

Key

- Order limits
- Habitat Mitigation Area
- Land outside Order limits

Rightwell House,
 Bretton,
 Peterborough, PE3 8DW
 Tel +44(0)1733 334455
 Email info.peterborough@rhdhv.com
 Website www.royalhaskoning.com

APPLICANT **ALTERNATIVE USE
 BOSTON PROJECTS LTD**

Disclaimer
 Do not scale from this drawing. Check all dimensions on site before fabrication or setting out. This document is copyright and may not be reproduced without permission of the owner.

REPRODUCED FROM ORDNANCE SURVEY MAPS
 WITH PERMISSION FROM
 THE CONTROLLER OF
 HER MAJESTY'S STATIONERY OFFICE
 CROWN COPYRIGHT RESERVED.
 LICENCE NUMBER. 100017728

REV	DATE	DESCRIPTION	BY	CHK	APP
0	19/03/2021	FOR SUBMISSION			

TITLE
**BOSTON ALTERNATIVE ENERGY FACILITY
 DEVELOPMENT CONSENT ORDER
 Regulation 5(4) - Indicative Generating Station Key Plan
 BOSTON BOROUGH COUNCIL
 SHEET 1 OF 1**

Application Number EN010095			
DRAWN MCP	CHECKED AG	APPROVED PS	
DATE 19/03/2021	SCALE AT A1 1:500	REF. PB6934	
DRAWING No. PB6934-RHD-01-ZZ-DR-4010	SUITABILITY S0	REVISION 0	

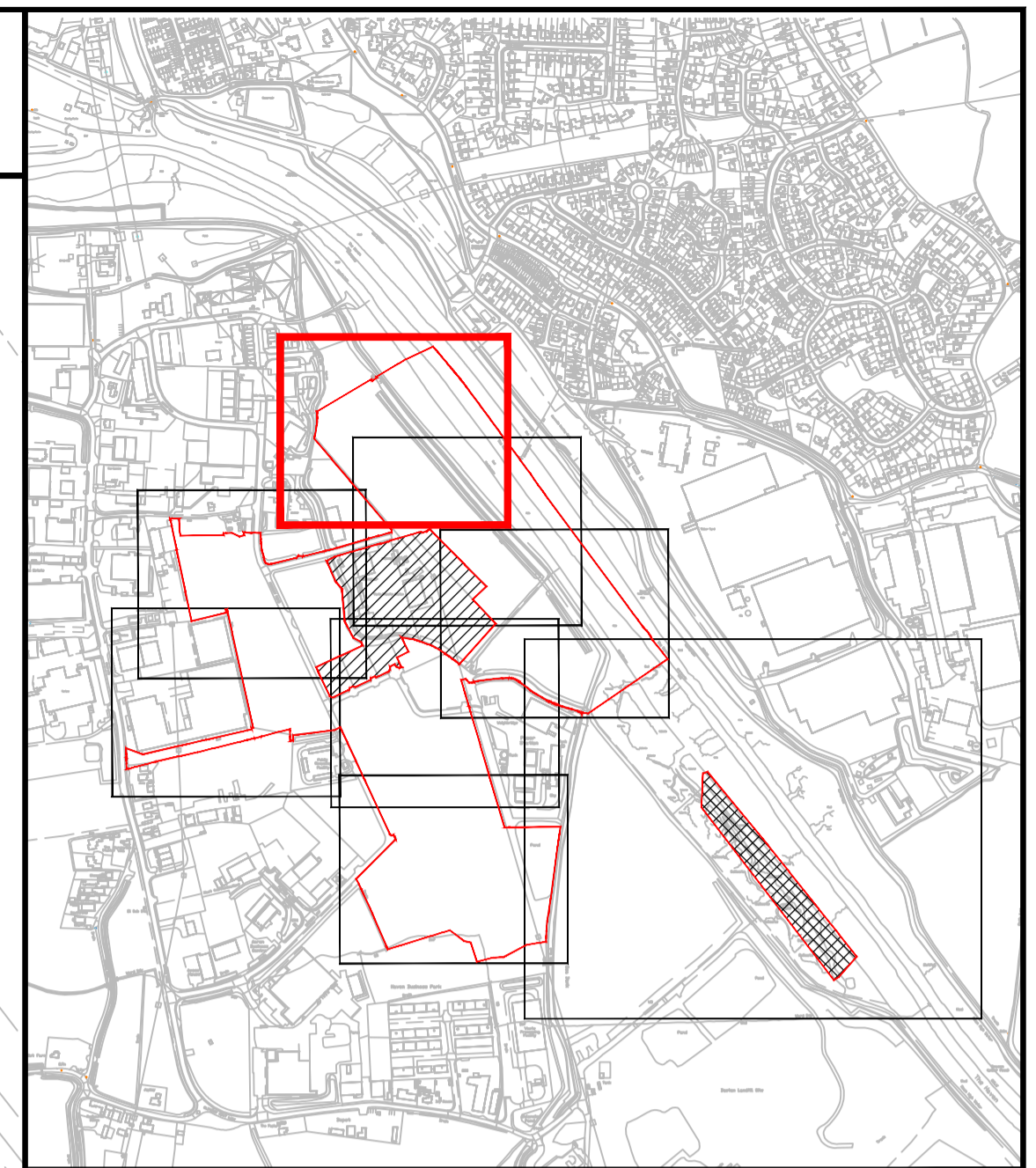
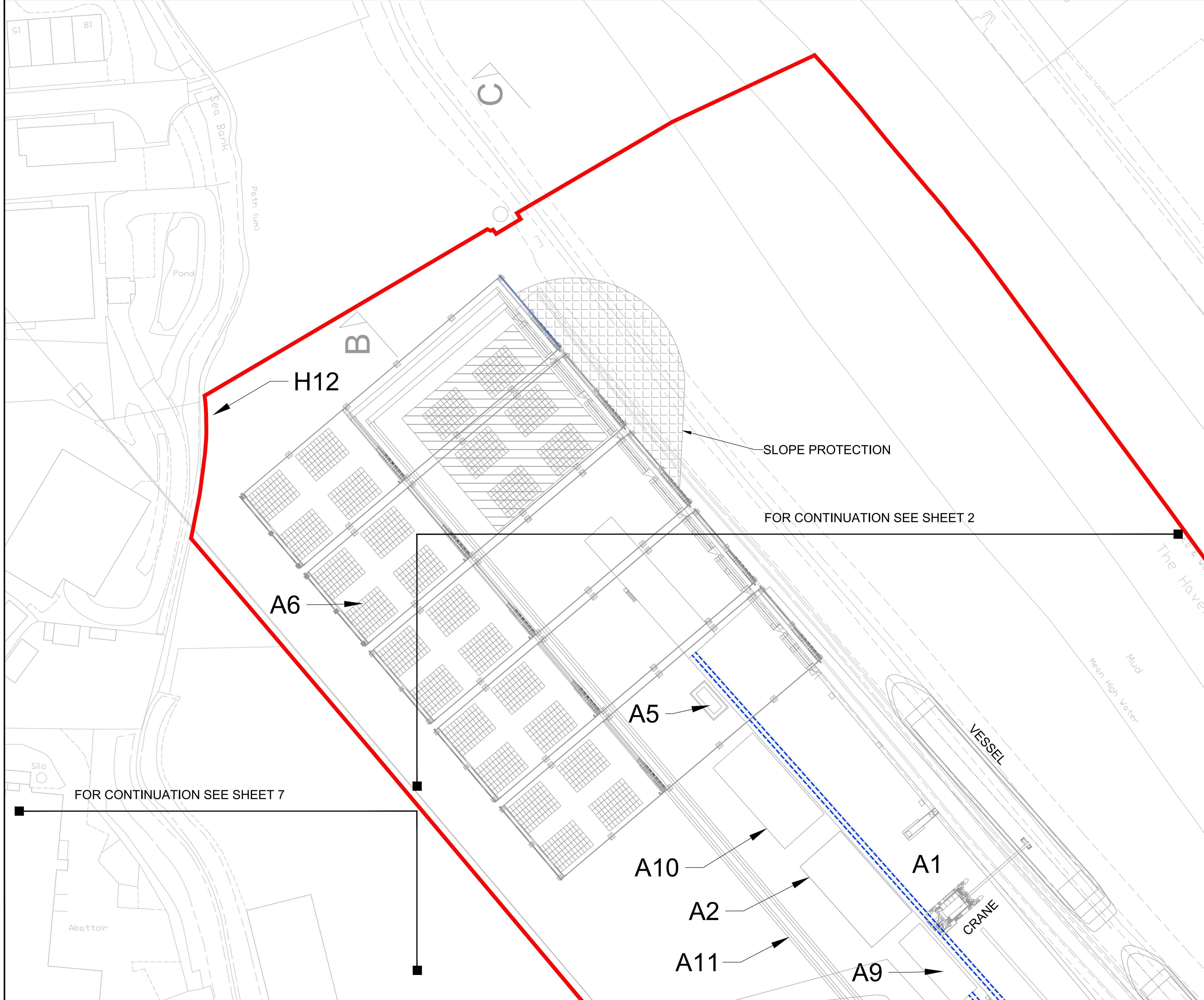
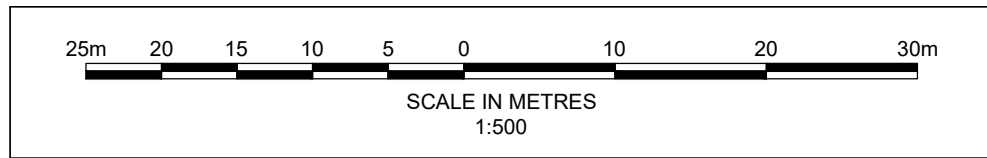

Key

- Order limits
- Slope Protection
- A1 Site item
- Pedestrian walkway

FOR DESCRIPTIONS OF SITE ITEMS SEE DRAWING
 PB6934-RHD-01-ZZ-DR-4011-S0-0 SHEET 10 OF 10

Royal HaskoningDHV
Enhancing Society Together

Rightwell House,
 Bretton,
 Peterborough, PE3 8DW
 Tel +44(0)1733 334455
 Email info.peterborough@rhdhv.com
 Website www.royalhaskoning.com

APPLICANT **ALTERNATIVE USE BOSTON PROJECTS LTD**

Disclaimer
 Do not scale from this drawing. Check all dimensions on site before fabrication or setting out. This document is copyright and may not be reproduced without permission of the owner.

REPRODUCED FROM ORDNANCE SURVEY MAPS WITH PERMISSION FROM THE CONTROLLER OF HER MAJESTY'S STATIONERY OFFICE. CROWN COPYRIGHT RESERVED.
 LICENCE NUMBER. 100017728

REV	DATE	DESCRIPTION	BY	CHK	APP
0	19/03/2021	FOR SUBMISSION		MCP	AG PS

TITLE
 BOSTON ALTERNATIVE ENERGY FACILITY DEVELOPMENT CONSENT ORDER
 Regulation 5(2)(c) - Indicative Generating Station Plans
 BOSTON BOROUGH COUNCIL
 SHEET 1 OF 10

Application Number EN010095					
DRAWN	MCP	CHECKED	AG	APPROVED	PS
DATE	19/03/2021	SCALE AT A1	1:500	REF.	PB6934
DRAWING No.	PB6934-RHD-01-ZZ-DR-4011	SUITABILITY	S0	REVISION	0

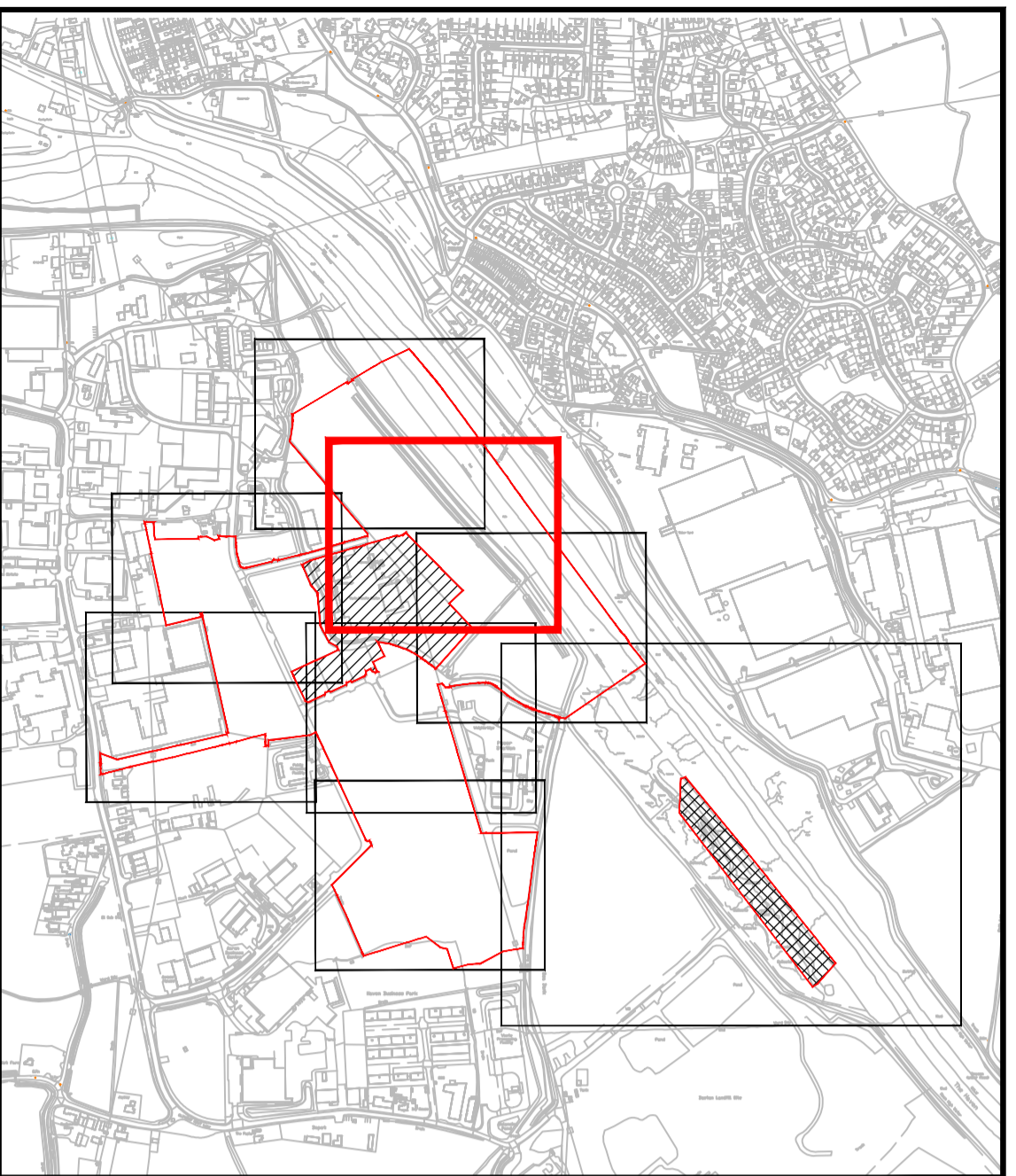
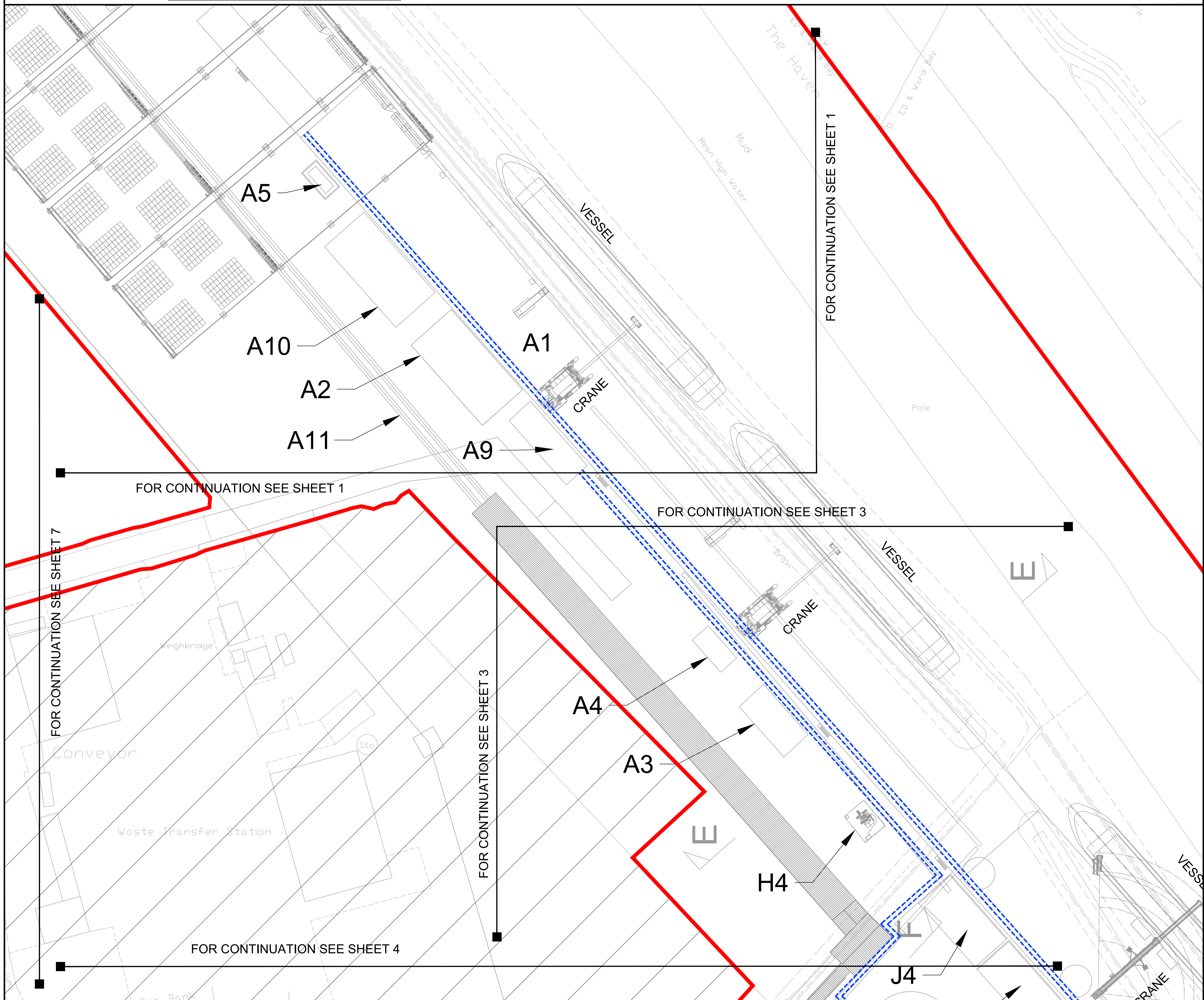
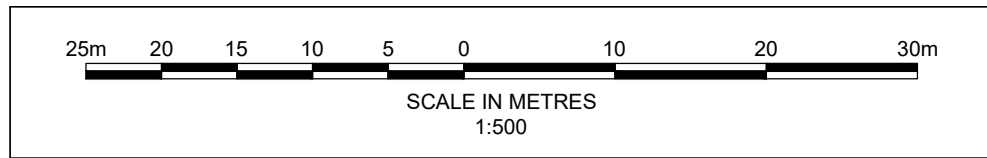

Key

- Order limits
- Land outside Order limits
- A1 Site item
- Pedestrian walkway

FOR DESCRIPTIONS OF SITE ITEMS SEE DRAWING
 PB6934-RHD-01-ZZ-DR-4011-S0-0 SHEET 10 OF 10

Royal HaskoningDHV
Enhancing Society Together

Rightwell House,
 Bretton,
 Peterborough, PE3 8DW
 Tel +44(0)1733 334455
 Email info.peterborough@rhdhv.com
 Website www.royalhaskoning.com

APPLICANT **ALTERNATIVE USE
 BOSTON PROJECTS LTD**

Disclaimer
 Do not scale from this drawing. Check all dimensions on site before fabrication or setting out. This document is copyright and may not be reproduced without permission of the owner.

REPRODUCED FROM ORDNANCE SURVEY MAPS
 WITH PERMISSION FROM
 THE CONTROLLER OF
 HER MAJESTY'S STATIONERY OFFICE
 CROWN COPYRIGHT RESERVED.
 LICENCE NUMBER. 100017728

REV	DATE	DESCRIPTION	BY	CHK	APP
0	19/03/2021	FOR SUBMISSION	MCP	AG	PS

TITLE
 BOSTON ALTERNATIVE ENERGY FACILITY
 DEVELOPMENT CONSENT ORDER
 Regulation 5(2)(c) - Indicative Generating Station Plans
 BOSTON BOROUGH COUNCIL
 SHEET 2 OF 10

Application Number EN010095					
DRAWN	MCP	CHECKED	AG	APPROVED	PS
DATE	19/03/2021	SCALE AT A1	1:500	REF.	PB6934
DRAWING No.	PB6934-RHD-01-ZZ-DR-4011	SUITABILITY	S0	REVISION	0

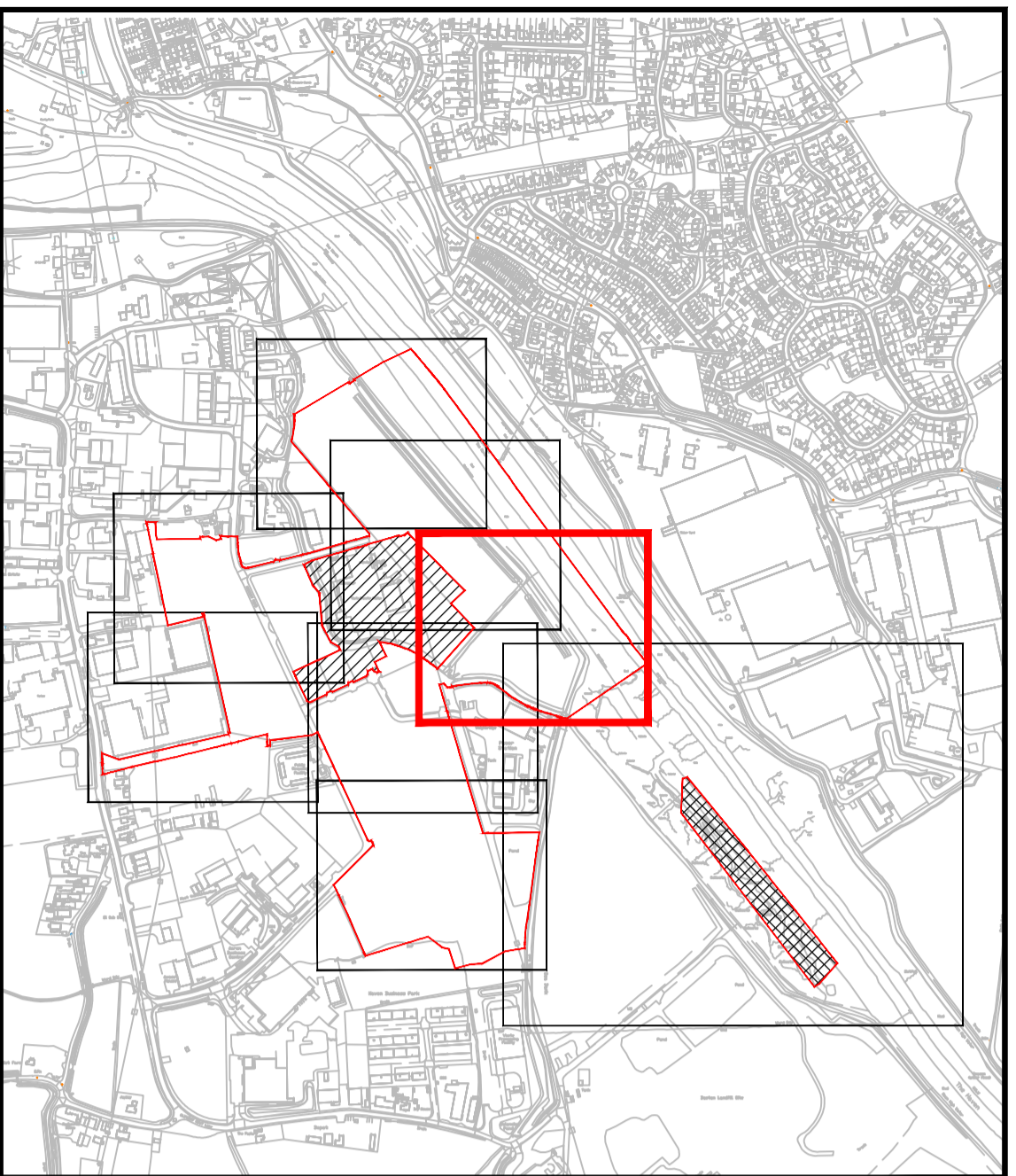
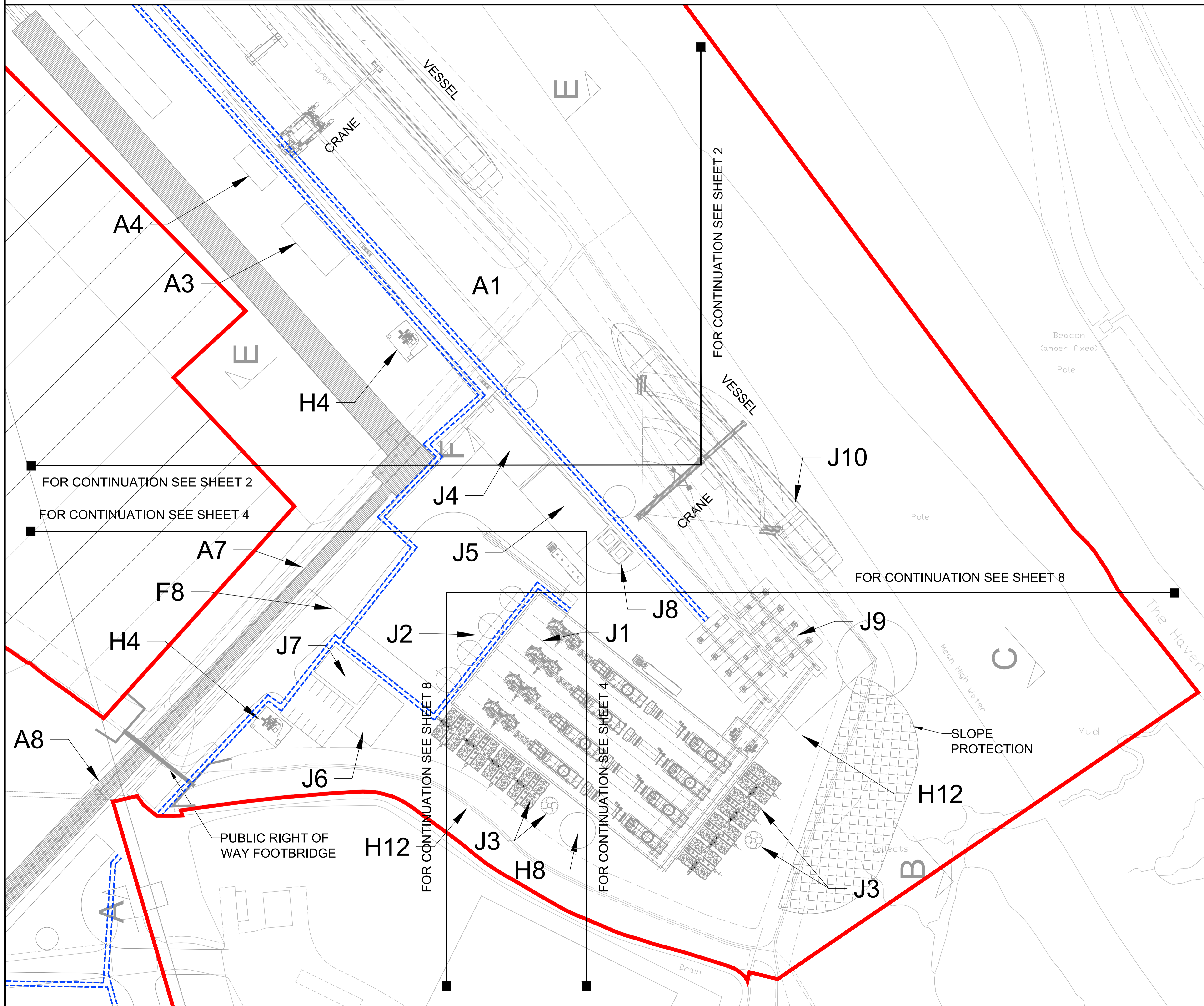
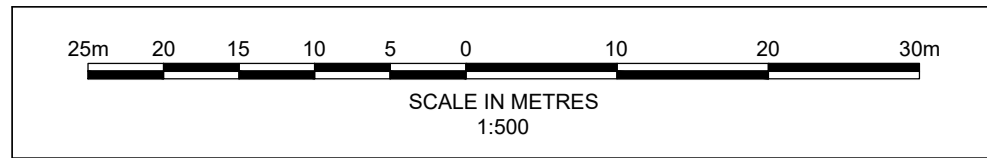

- Key**
- Order limits
 - Land outside Order limits
 - Slope Protection
 - A1 Site item
 - Pedestrian walkway

FOR DESCRIPTIONS OF SITE ITEMS SEE DRAWING
 PB6934-RHD-01-ZZ-DR-4011-S0-0 SHEET 10 OF 10

Royal HaskoningDHV
Enhancing Society Together

Rightwell House,
 Bretton,
 Peterborough, PE3 8DW
 Tel +44(0)1733 334455
 Email info.peterborough@rhdhv.com
 Website www.royalhaskoning.com

APPLICANT **ALTERNATIVE USE BOSTON PROJECTS LTD**

Disclaimer
 Do not scale from this drawing. Check all dimensions on site before fabrication or setting out. This document is copyright and may not be reproduced without permission of the owner.

REPRODUCED FROM ORDNANCE SURVEY MAPS WITH PERMISSION FROM THE CONTROLLER OF HER MAJESTY'S STATIONERY OFFICE. CROWN COPYRIGHT RESERVED.
 LICENCE NUMBER. 100017728

REV	DATE	DESCRIPTION	BY	CHK	APP
0	19/03/2021	FOR SUBMISSION	MCP	AG	PS

TITLE
 BOSTON ALTERNATIVE ENERGY FACILITY DEVELOPMENT CONSENT ORDER
 Regulation 5(2)(o) - Indicative Generating Station Plans
 BOSTON BOROUGH COUNCIL
 SHEET 3 OF 10

Application Number **EN010095**

DRAWN	MCP	CHECKED	AG	APPROVED	PS
DATE	19/03/2021	SCALE AT A1	1:500	REF.	PB6934
DRAWING No.	PB6934-RHD-01-ZZ-DR-4011	SUITABILITY	S0	REVISION	0

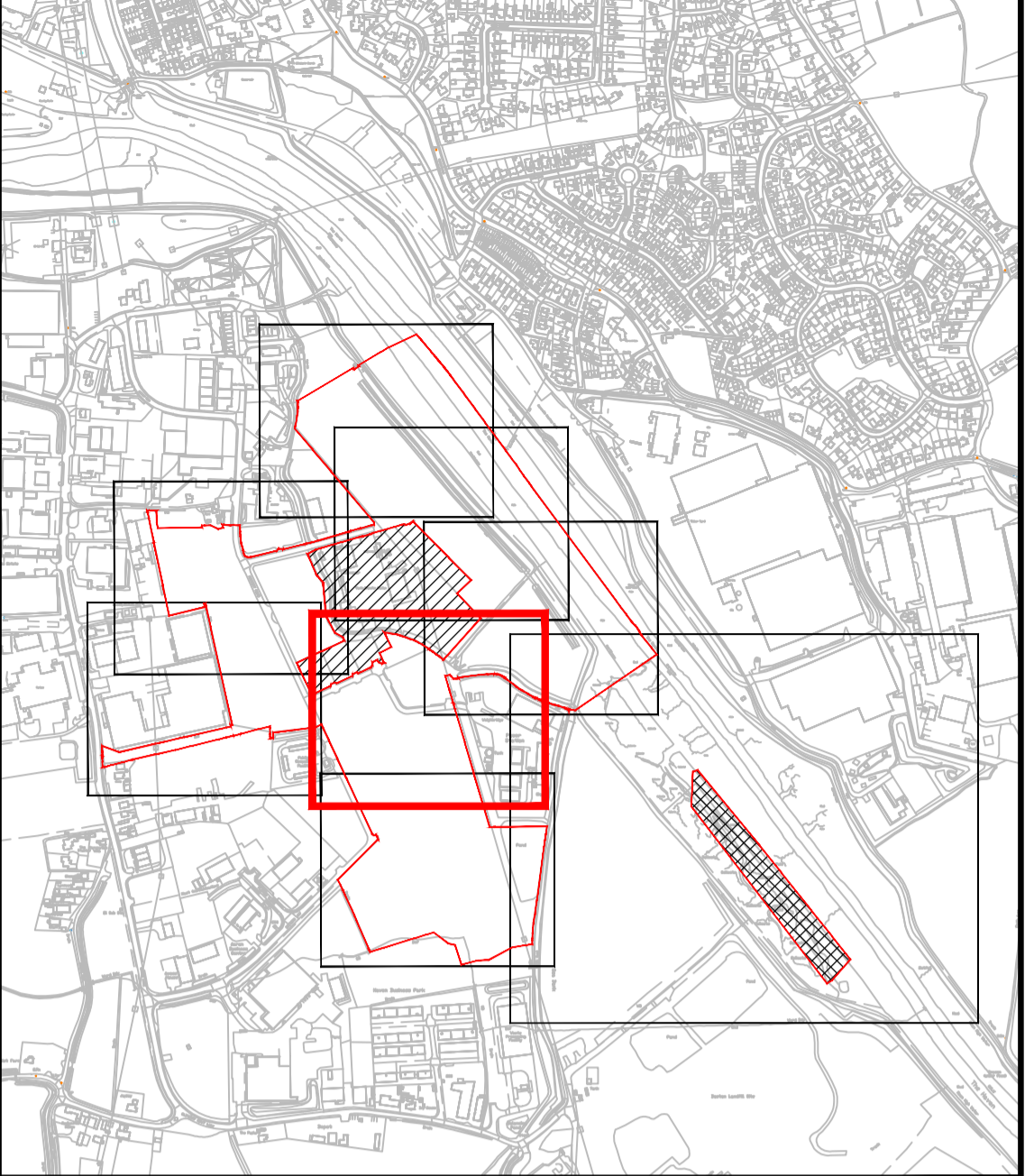
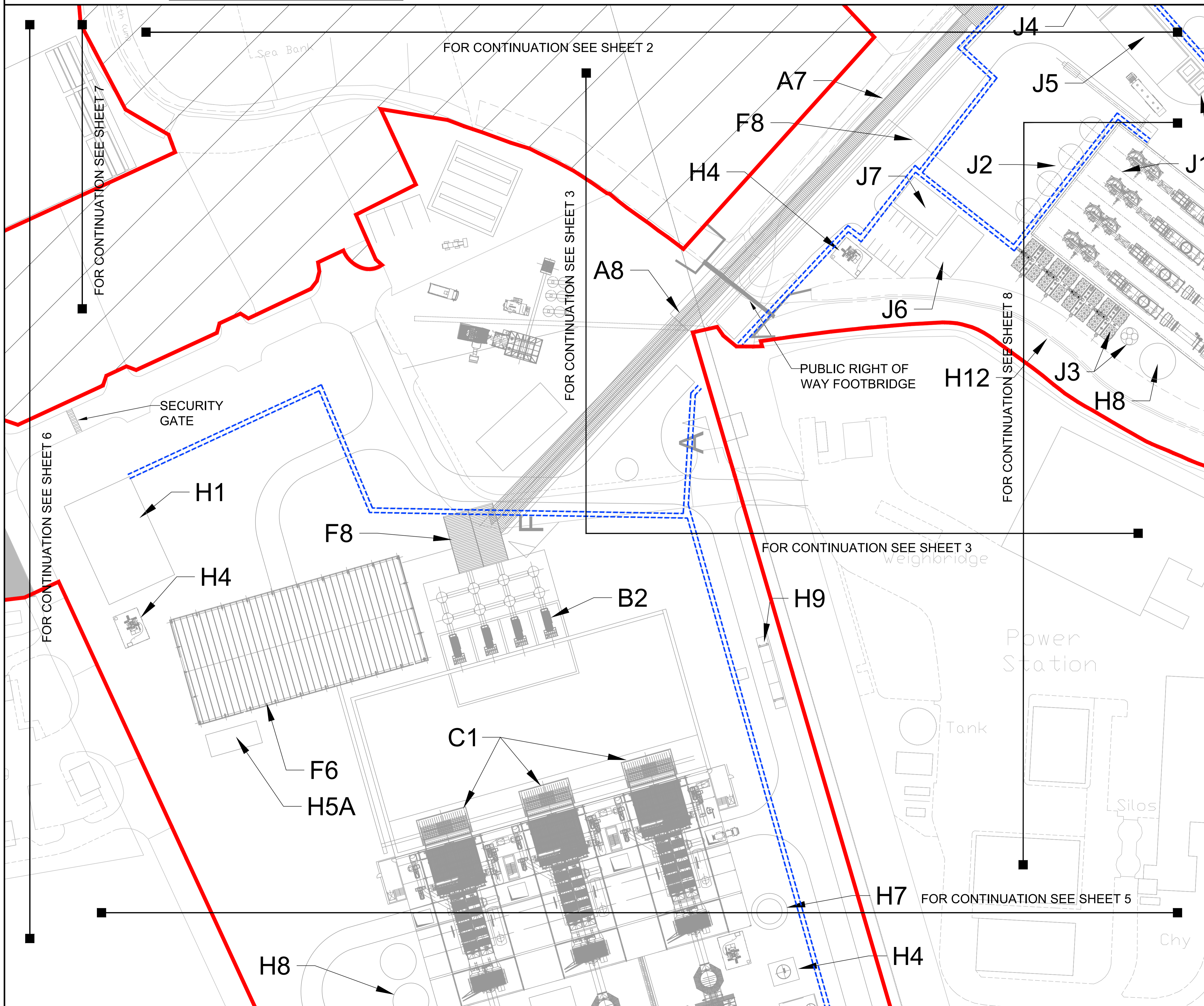
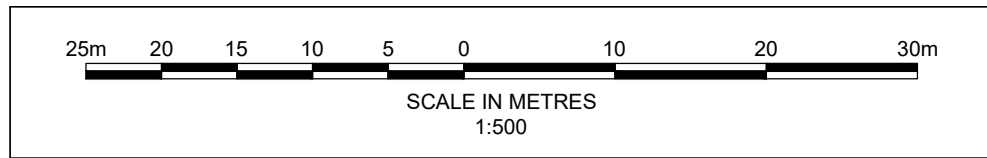

Key
 Order limits
 Land outside Order limits
 A1 Site item
 Pedestrian walkway

FOR DESCRIPTIONS OF SITE ITEMS SEE DRAWING
 PB6934-RHD-01-ZZ-DR-4011-S0-0 SHEET 10 OF 10

Royal HaskoningDHV
 Enhancing Society Together

Rightwell House,
 Bretton,
 Peterborough, PE3 8DW
 Tel +44(0)1733 334455
 Email info.peterborough@rhdhv.com
 Website www.royalhaskoning.com

APPLICANT: **ALTERNATIVE USE BOSTON PROJECTS LTD**

Disclaimer
 Do not scale from this drawing. Check all dimensions on site before fabrication or setting out. This document is copyright and may not be reproduced without permission of the owner.

REPRODUCED FROM ORDNANCE SURVEY MAPS WITH PERMISSION FROM THE CONTROLLER OF HER MAJESTY'S STATIONERY OFFICE. CROWN COPYRIGHT RESERVED.
 LICENCE NUMBER. 100017728

REV	DATE	DESCRIPTION	BY	CHK	APP
0	19/03/2021	FOR SUBMISSION	MCP	AG	PS

TITLE: **BOSTON ALTERNATIVE ENERGY FACILITY DEVELOPMENT CONSENT ORDER Regulation 5(2)(c) - Indicative Generating Station Plans BOSTON BOROUGH COUNCIL SHEET 4 OF 10**

Application Number: **EN010095**

DRAWN: MCP	CHECKED: AG	APPROVED: PS
DATE: 19/03/2021	SCALE: AT A1 1:500	REF: PB6934
DRAWING No: PB6934-RHD-01-ZZ-DR-4011	SUITABILITY: S0	REVISION: 0

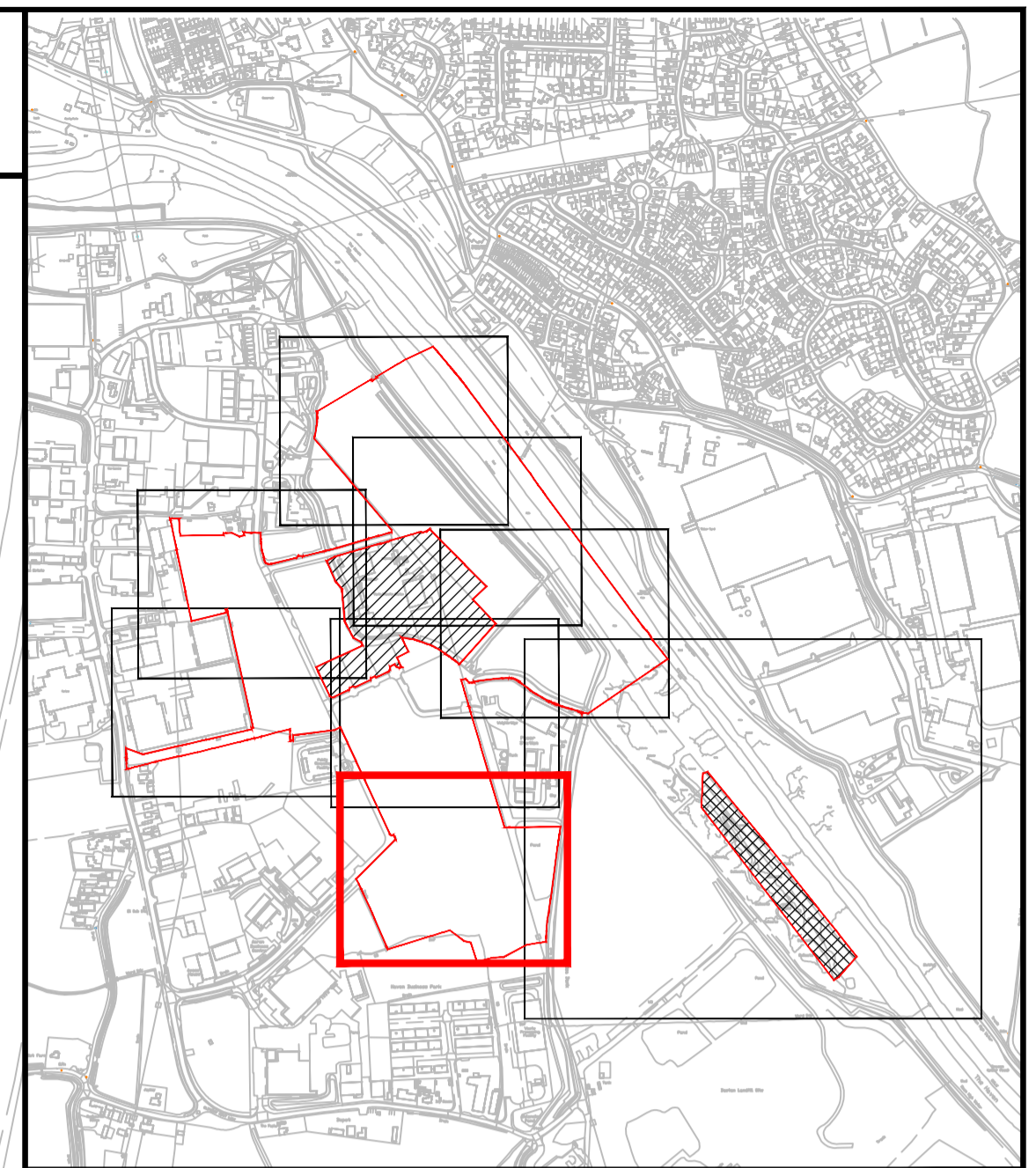
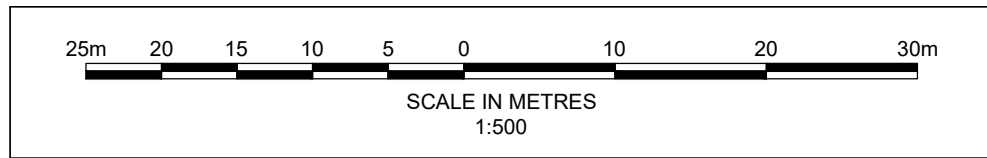

Key
 Order limits
 A1 Site item
 Pedestrian walkway

FOR DESCRIPTIONS OF SITE ITEMS SEE DRAWING
 PB6934-RHD-01-ZZ-DR-4011-S0-0 SHEET 10 OF 10

Royal HaskoningDHV
Enhancing Society Together

Rightwell House,
 Bretton,
 Peterborough, PE3 8DW
 Tel +44(0)1733 334455
 Email info.peterborough@rhdhv.com
 Website www.royalhaskoning.com

APPLICANT: **ALTERNATIVE USE BOSTON PROJECTS LTD**

Disclaimer
 Do not scale from this drawing. Check all dimensions on site before fabrication or setting out. This document is copyright and may not be reproduced without permission of the owner.

REPRODUCED FROM ORDNANCE SURVEY MAPS WITH PERMISSION FROM THE CONTROLLER OF HER MAJESTY'S STATIONERY OFFICE. CROWN COPYRIGHT RESERVED.
 LICENCE NUMBER. 100017728

REV	DATE	DESCRIPTION	BY	CHK	APP
0	19/03/2021	FOR SUBMISSION	MCP	AG	PS

TITLE: **BOSTON ALTERNATIVE ENERGY FACILITY DEVELOPMENT CONSENT ORDER Regulation 5(2)(c) - Indicative Generating Station Plans BOSTON BOROUGH COUNCIL SHEET 5 OF 10**

Application Number: **EN010095**

DRAWN	CHECKED	APPROVED
MCP	AG	PS
DATE	SCALE AT A1	REF.
19/03/2021	1:500	PB6934

DRAWING No: **PB6934-RHD-01-ZZ-DR-4011** SLITABILITY: **S0** REVISION: **0**

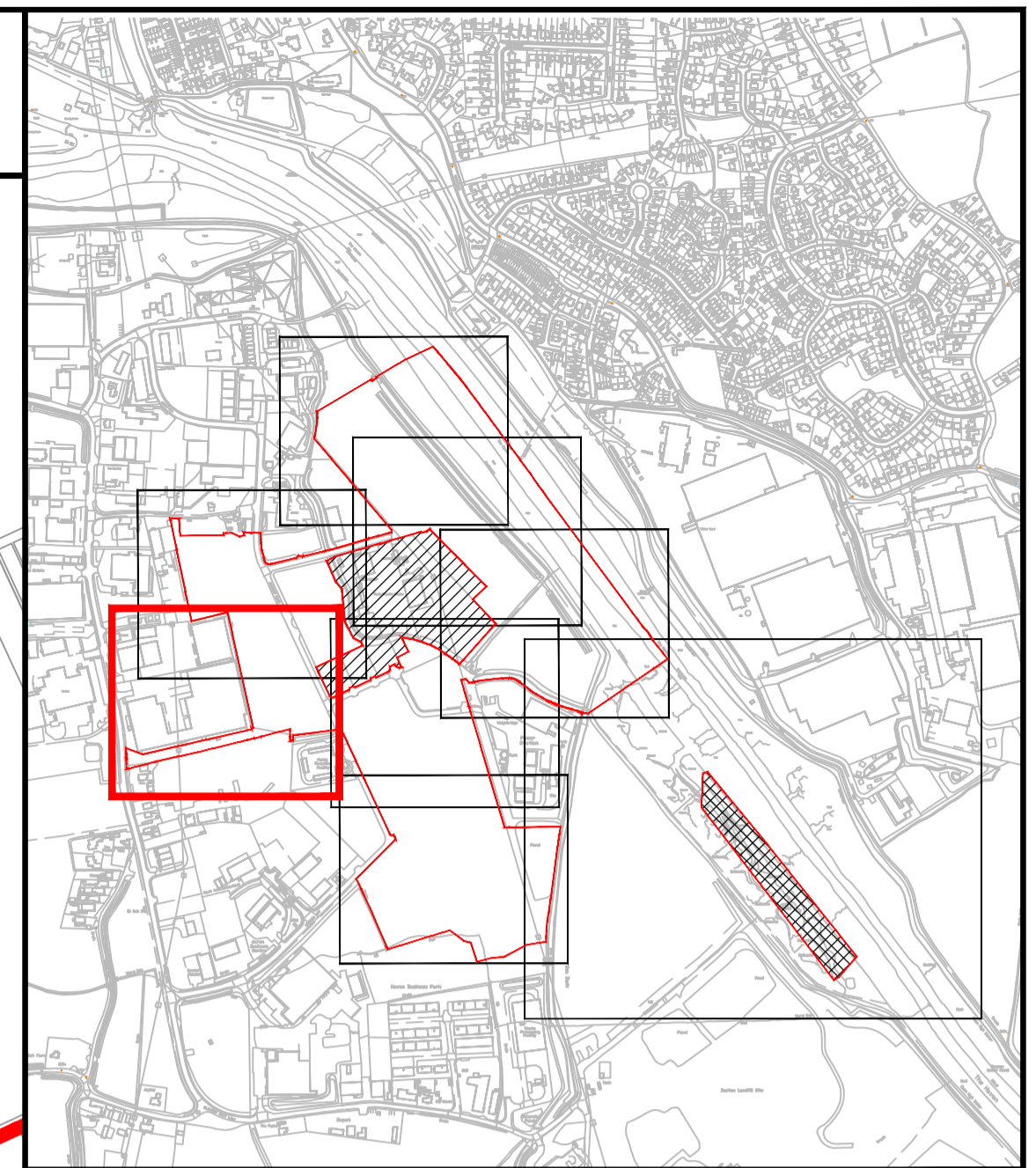
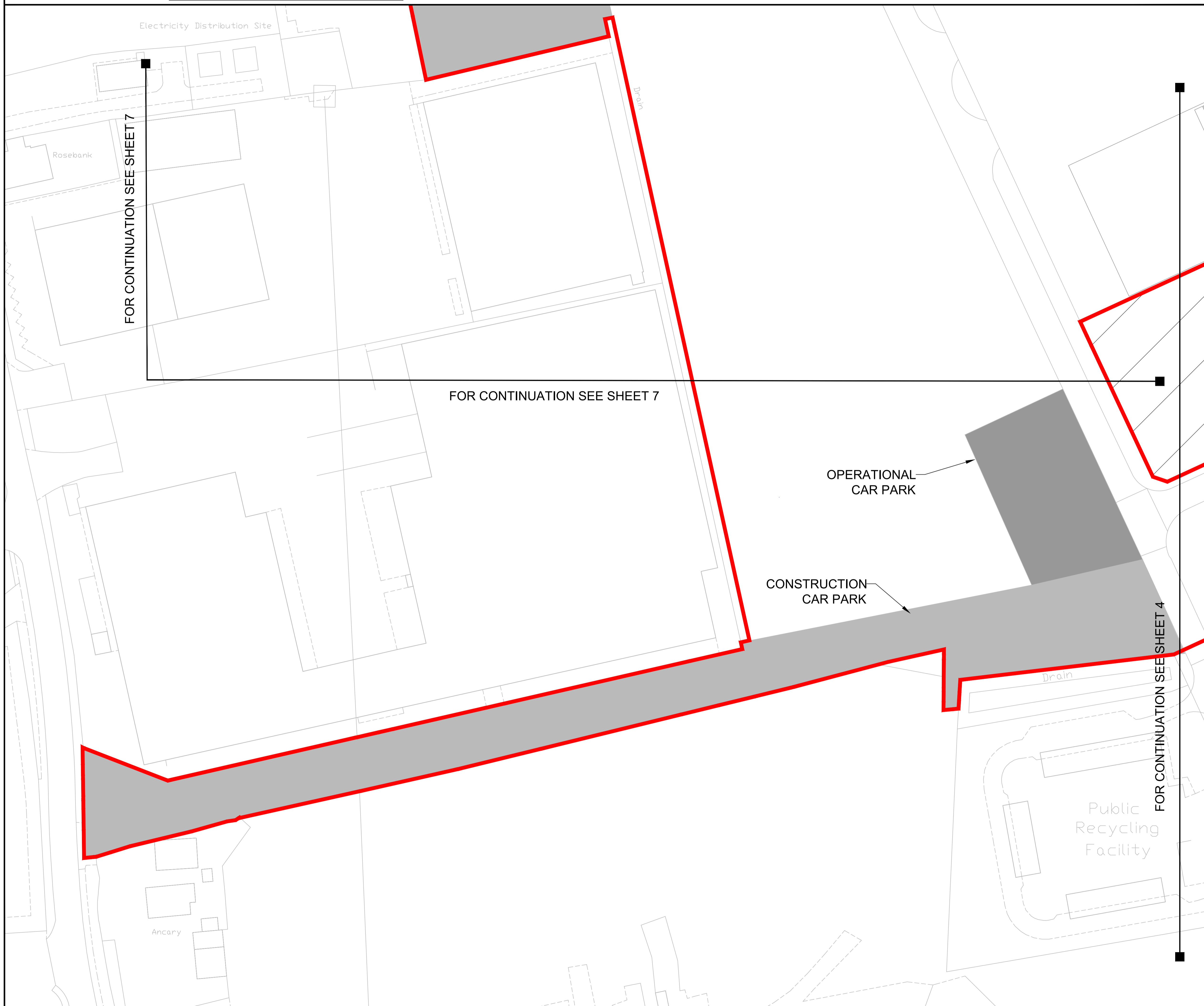
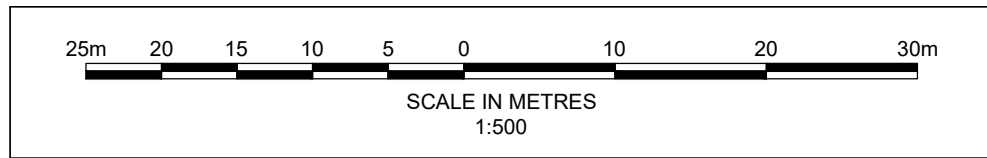

Key

- Order limits
- Land outside Order limits
- Construction Car Parks
- Operational Car Park

FOR DESCRIPTIONS OF SITE ITEMS SEE DRAWING
 PB6934-RHD-01-ZZ-DR-4011-S0-0 SHEET 10 OF 10



Royal HaskoningDHV
Enhancing Society Together

Rightwell House,
 Bretton,
 Peterborough, PE3 8DW
 Tel +44(0)1733 334455
 Email info.peterborough@rhdhv.com
 Website www.royalhaskoning.com

APPLICANT **ALTERNATIVE USE
 BOSTON PROJECTS LTD**

Disclaimer
 Do not scale from this drawing. Check all dimensions on site before fabrication or setting out. This document is copyright and may not be reproduced without permission of the owner.

REPRODUCED FROM ORDNANCE SURVEY MAPS
 WITH PERMISSION FROM
 THE CONTROLLER OF
 HER MAJESTY'S STATIONERY OFFICE
 CROWN COPYRIGHT RESERVED.
 LICENCE NUMBER. 100017728

REV	DATE	DESCRIPTION	BY	CHK	APP
0	19/03/2021	FOR SUBMISSION	MCP	AG	PS

TITLE
**BOSTON ALTERNATIVE ENERGY FACILITY
 DEVELOPMENT CONSENT ORDER
 Regulation 5(2)(o) - Indicative Generating Station Plans
 BOSTON BOROUGH COUNCIL
 SHEET 6 OF 10**

Application Number
EN010095

DRAWN MCP	CHECKED AG	APPROVED PS
DATE 19/03/2021	SCALE AT A1 1:500	REF. PB6934
DRAWING No. PB6934-RHD-01-ZZ-DR-4011	SUITABILITY S0	REVISION 0

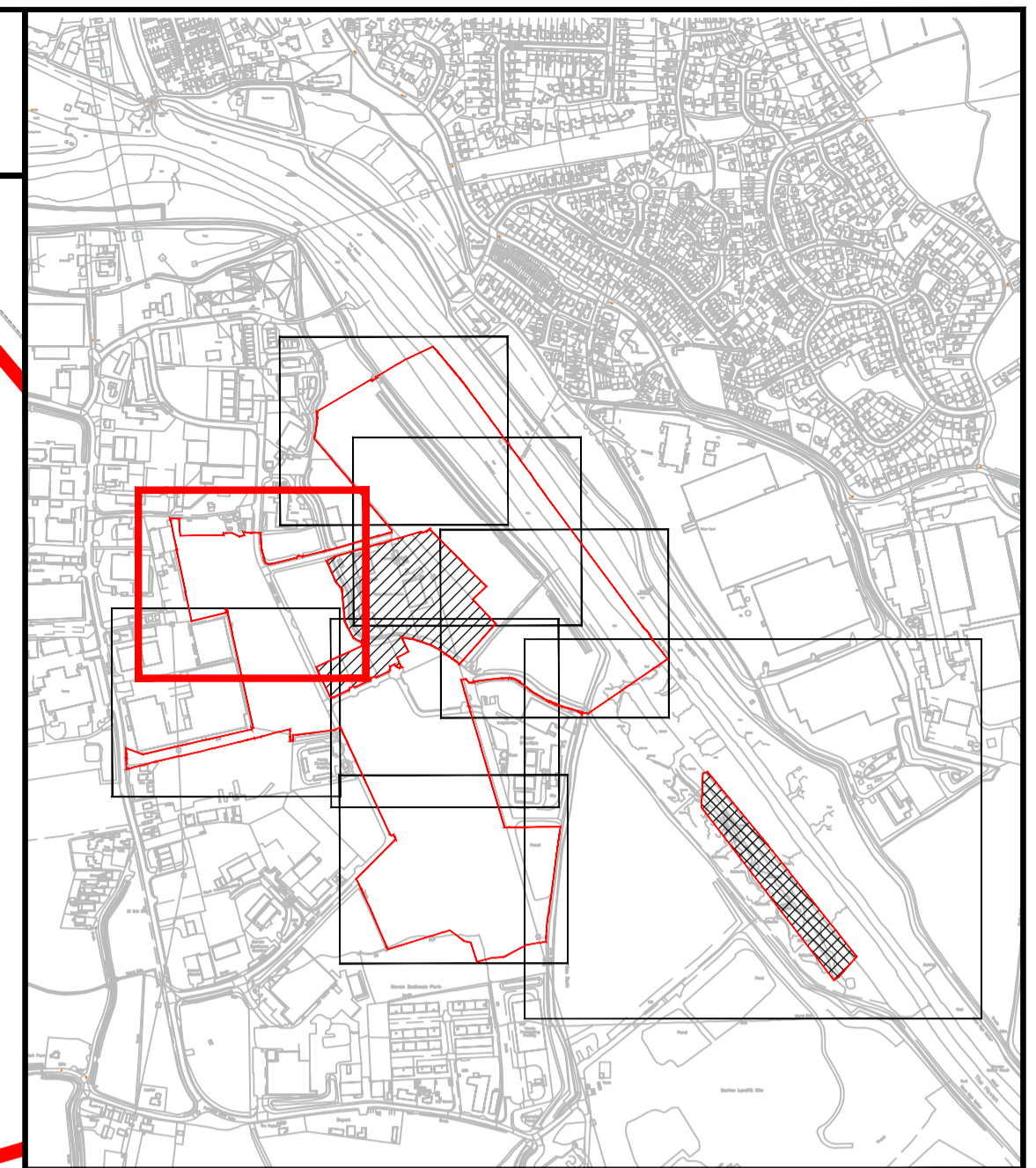
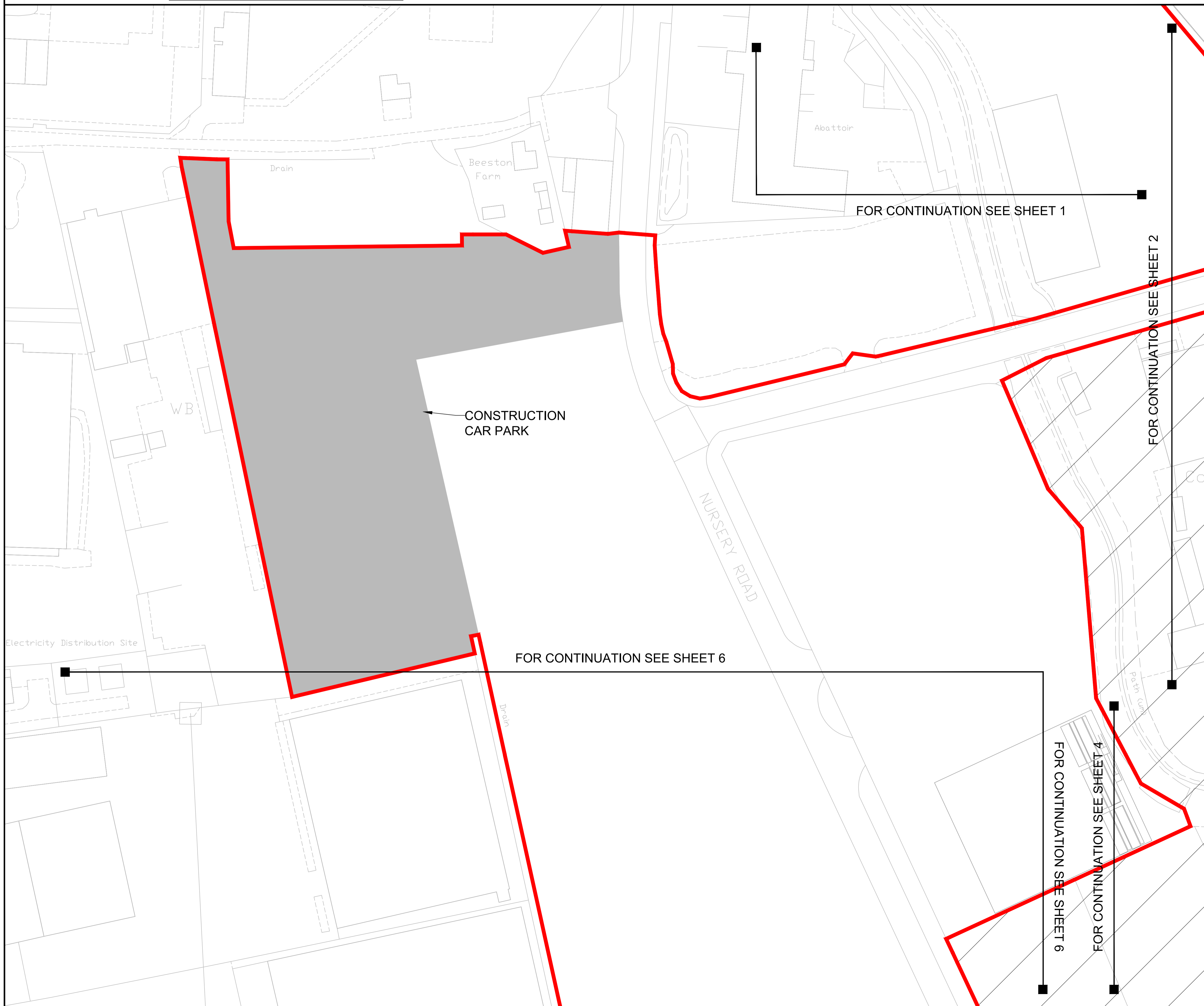
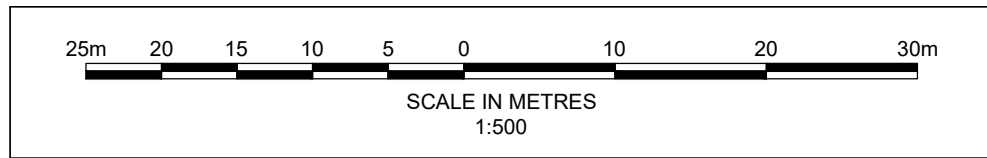

Key

- Order limits
- Land outside Order limits
- Construction Car Park

FOR DESCRIPTIONS OF SITE ITEMS SEE DRAWING
 PB6934-RHD-01-ZZ-DR-4011-S0-0 SHEET 10 OF 10

Royal HaskoningDHV
Enhancing Society Together

Rightwell House,
 Bretton,
 Peterborough, PE3 8DW
 Tel +44(0)1733 334455
 Email info.peterborough@rhdhv.com
 Website www.royalhaskoning.com

APPLICANT **ALTERNATIVE USE
 BOSTON PROJECTS LTD**

Disclaimer
 Do not scale from this drawing. Check all dimensions on site before fabrication or setting out. This document is copyright and may not be reproduced without permission of the owner.

REPRODUCED FROM ORDNANCE SURVEY MAPS
 WITH PERMISSION FROM
 THE CONTROLLER OF
 HER MAJESTY'S STATIONERY OFFICE
 CROWN COPYRIGHT RESERVED.
 LICENCE NUMBER. 100017728

REV	DATE	DESCRIPTION	BY	CHK	APP
0	19/03/2021	FOR SUBMISSION		MCP	AG PS

TITLE
 BOSTON ALTERNATIVE ENERGY FACILITY
 DEVELOPMENT CONSENT ORDER
 Regulation 5(2)(c) - Indicative Generating Station Plans
 BOSTON BOROUGH COUNCIL
 SHEET 7 OF 10

Application Number
EN010095

DRAWN	CHECKED	APPROVED
MCP	AG	PS
DATE	SCALE AT A1	REF.
19/03/2021	1:500	PB6934
DRAWING No.	SUITABILITY	REVISION
PB6934-RHD-01-ZZ-DR-4011	S0	0

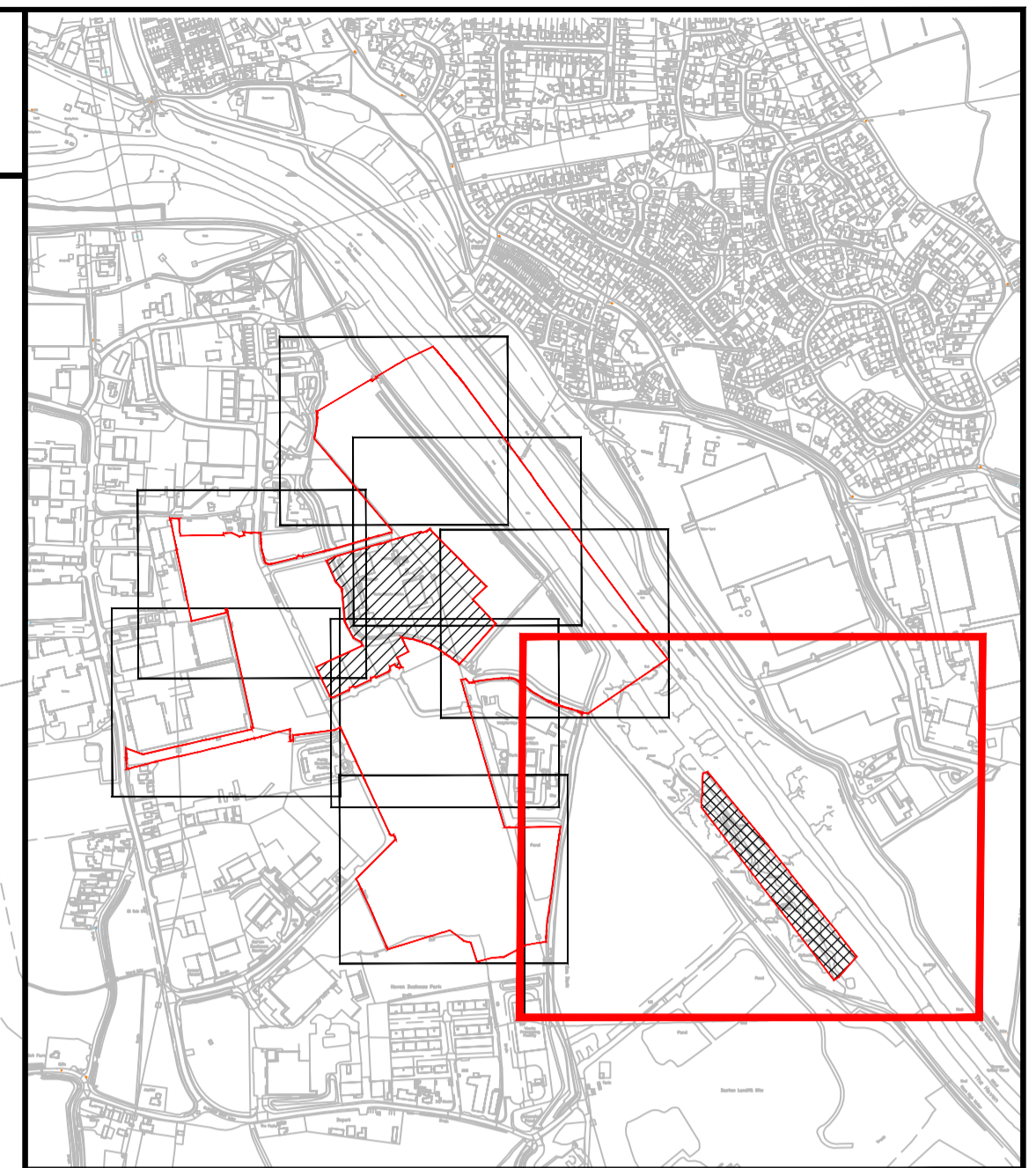
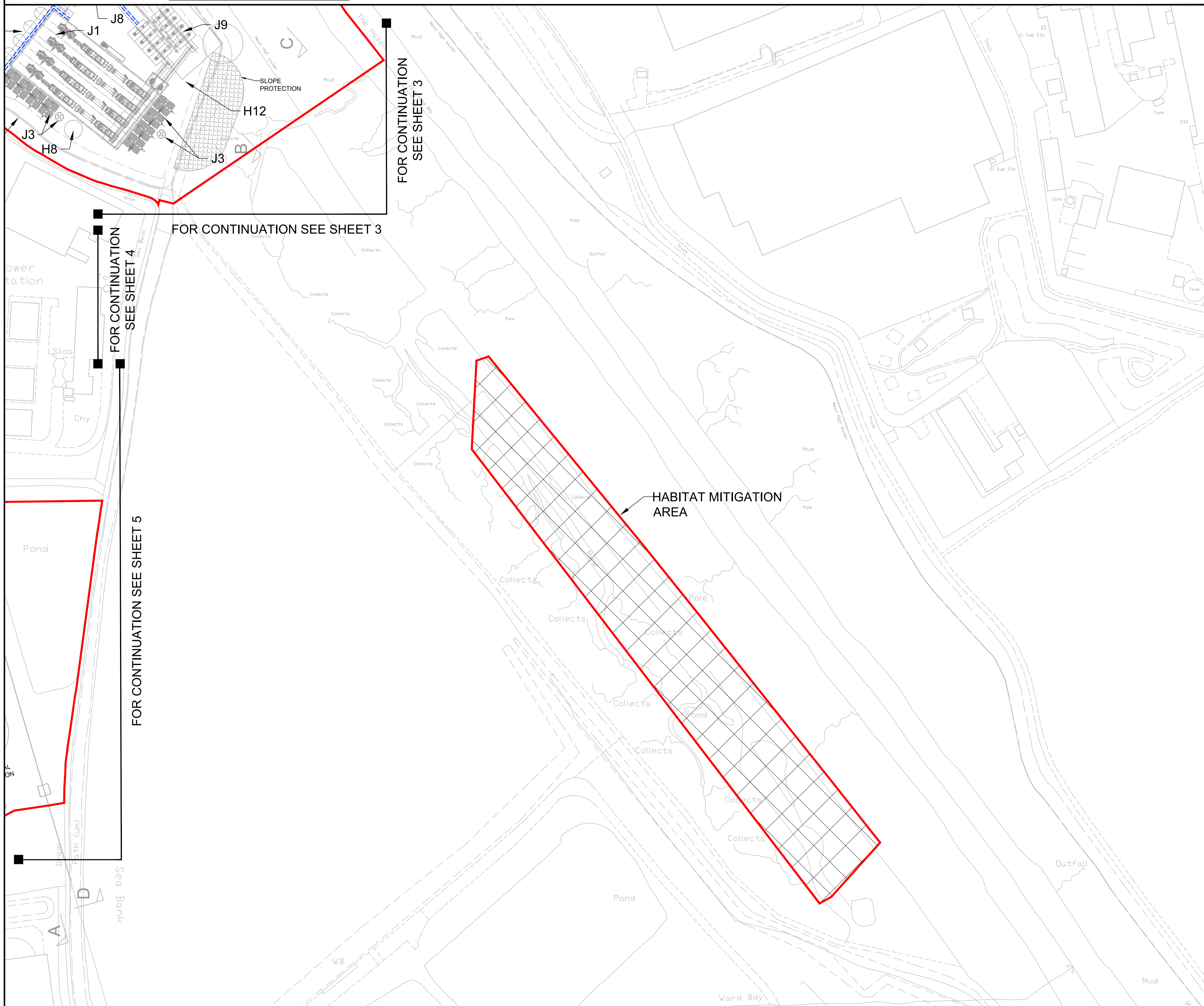
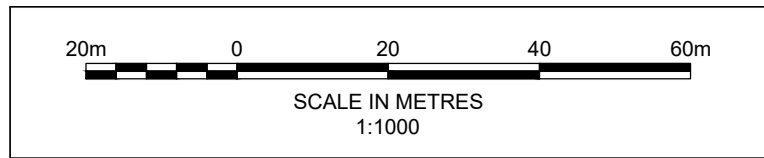

Key

- Order limits
- Habitat Mitigation Area
- Slope Protection
- A1 Site item
- Pedestrian walkway

FOR DESCRIPTIONS OF SITE ITEMS SEE DRAWING
 PB6934-RHD-01-ZZ-DR-4011-S0-0 SHEET 10 OF 10



Royal HaskoningDHV
Enhancing Society Together

Rightwell House,
 Bretton,
 Peterborough, PE3 8DW
 Tel +44(0)1733 334455
 Email info.peterborough@rhdhv.com
 Website www.royalhaskoning.com

APPLICANT **ALTERNATIVE USE
 BOSTON PROJECTS LTD**

Disclaimer
 Do not scale from this drawing. Check all dimensions on site before fabrication or setting out. This document is copyright and may not be reproduced without permission of the owner.

REPRODUCED FROM ORDNANCE SURVEY MAPS
 WITH PERMISSION FROM
 THE CONTROLLER OF
 HER MAJESTY'S STATIONERY OFFICE
 CROWN COPYRIGHT RESERVED.
 LICENCE NUMBER. 100017728

REV	DATE	DESCRIPTION	BY	CHK	APP
0	19/03/2021	FOR SUBMISSION		MCP	AG PS

TITLE
 BOSTON ALTERNATIVE ENERGY FACILITY
 DEVELOPMENT CONSENT ORDER
 Regulation 5(2)(c) - Indicative Generating Station Plans
 BOSTON BOROUGH COUNCIL
 SHEET 8 OF 10

Application Number
EN010095

DRAWN	MCP	CHECKED	AG	APPROVED	PS
DATE	19/03/2021	SCALE AT A1	1:1000	REF.	PB6934

DRAWING No.	PB6934-RHD-01-ZZ-DR-4011	SUITABILITY	S0	REVISION	0
-------------	--------------------------	-------------	----	----------	---

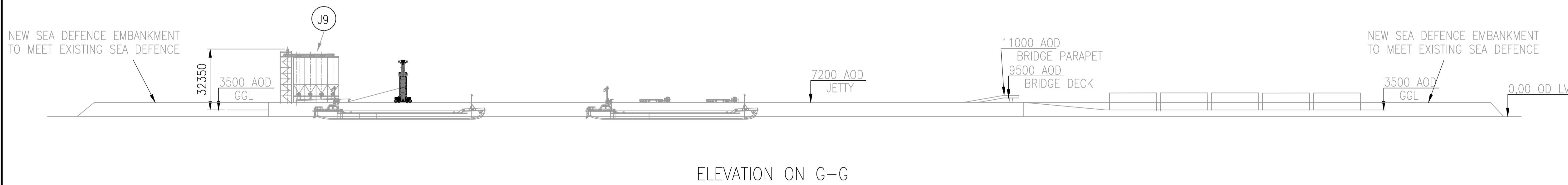
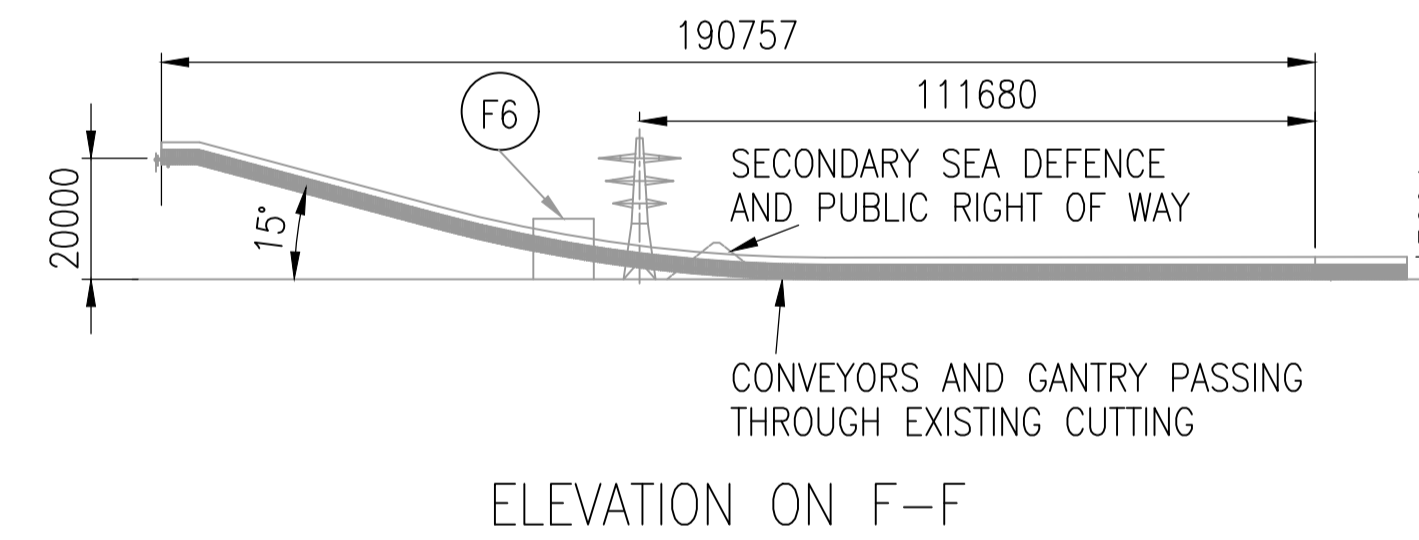
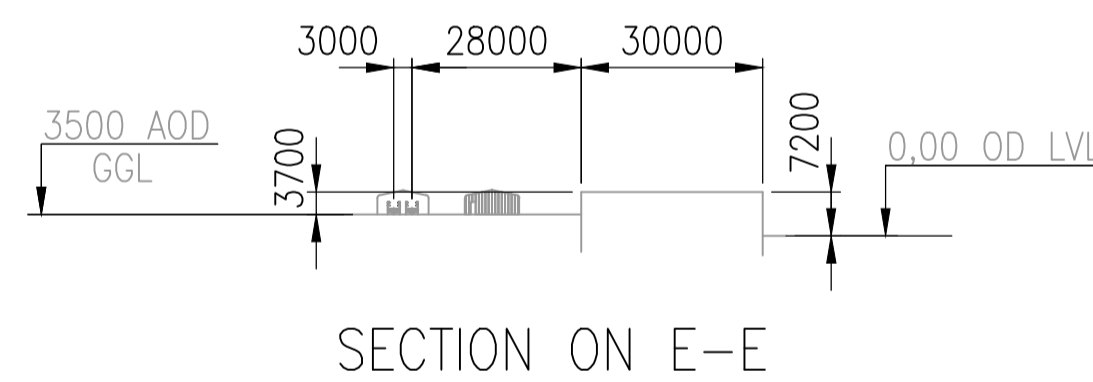
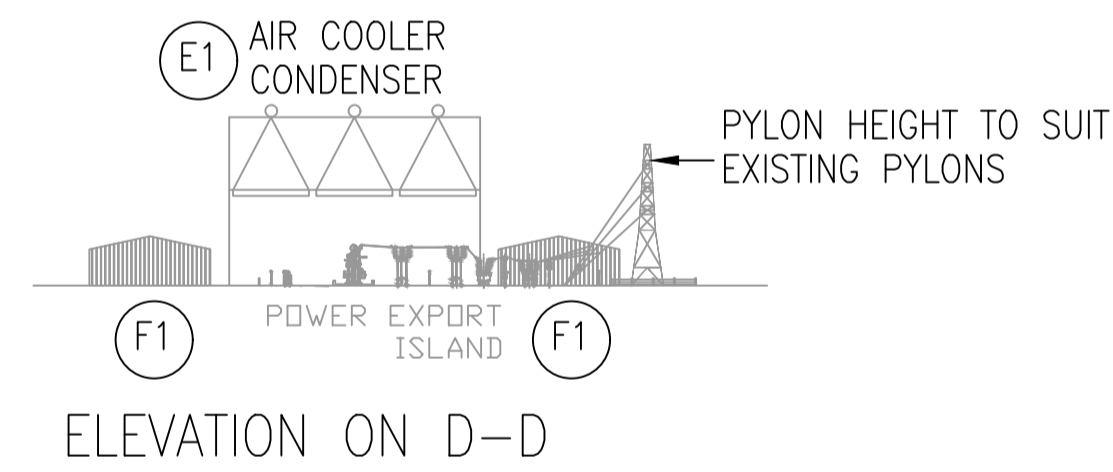
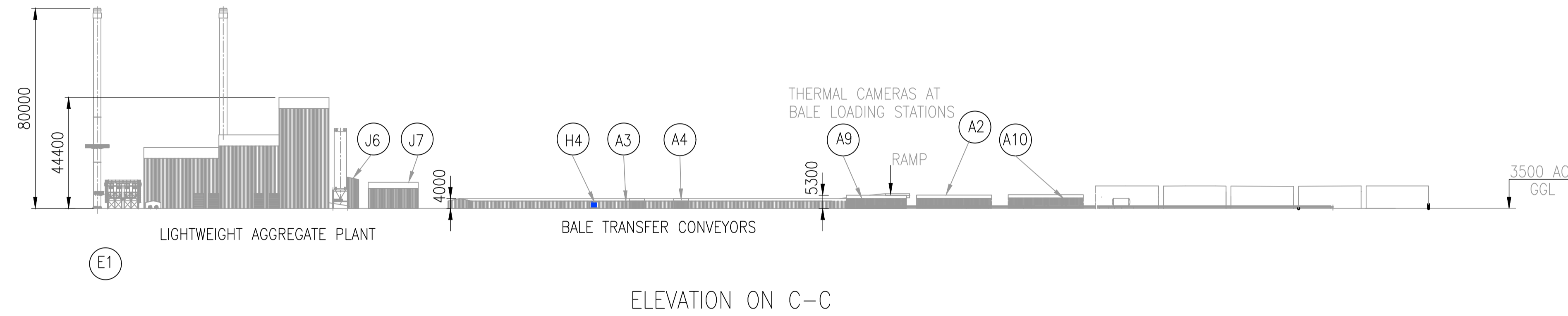
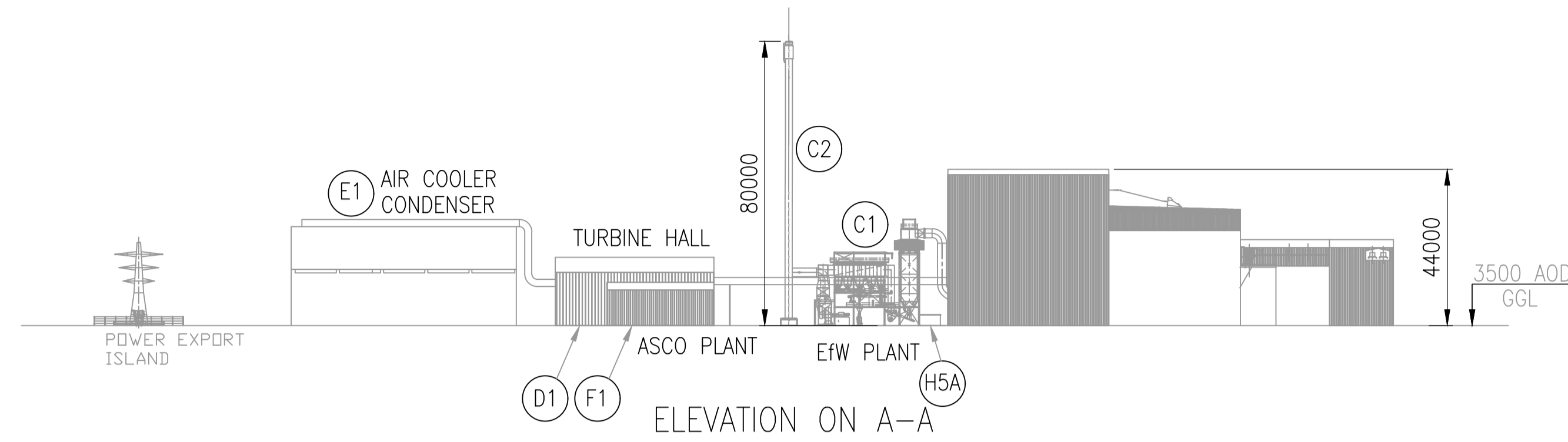

Key

(A1) Site item

FOR DESCRIPTIONS OF SITE ITEMS SEE DRAWING
 PB6934-RHD-01-ZZ-DR-4011-S0-0 SHEET 10 OF 10

Royal HaskoningDHV
 Enhancing Society Together

Rightwell House,
 Bretton,
 Peterborough, PE3 8DW
 Tel +44(0)1733 334455
 Email info.peterborough@rhdhv.com
 Website www.royalhaskoning.com

APPLICANT **ALTERNATIVE USE
 BOSTON PROJECTS LTD**

Disclaimer

Do not scale from this drawing. Check all dimensions on site before fabrication or setting out. This document is copyright and may not be reproduced without permission of the owner.

REPRODUCED FROM ORDNANCE SURVEY MAPS
 WITH PERMISSION FROM
 THE CONTROLLER OF
 HER MAJESTY'S STATIONERY OFFICE
 CROWN COPYRIGHT RESERVED.

LICENCE NUMBER. 100017728

REV	DATE	DESCRIPTION	BY	CHK	APP
0	19/03/2021	FOR SUBMISSION		MCP	AG PS

TITLE **BOSTON ALTERNATIVE ENERGY FACILITY
 DEVELOPMENT CONSENT ORDER
 Regulation 5(2)(o) - Indicative Generating Station Plans
 Sections and Elevations
 BOSTON BOROUGH COUNCIL
 SHEET 9 OF 10**

Application Number
EN010095

DRAWN	CHECKED	APPROVED
MCP	AG	PS
DATE	SCALE AT A1	REF.
19/03/2021	DO NOT SCALE	PB6934

DRAWING No.	SUITABILITY	REVISION
PB6934-RHD-01-ZZ-DR-4011	S0	0

ITEM NO.	PURPOSE	WORKS NO.
A1	New multi purpose wharf and primary flood defence	4(a)
A2	Re-baling facility	4(f)
A3	Fuel wharf personnel facility	5(f)
A4	Fuel wharf WC - unisex	5(f)
A5	Fuel wharf - mobile plant refueling	5(n)
A6	External bale storage	4(e)
A7	Bale transfer roller conveyors open and covered	4(c)
A8	Bale transfer belt conveyors covered	4(c)
A9	Damaged bale store	4(g)
A10	Mobile plant workshop including WC - unisex (5 staff)	4(j)
A11	Bale transfer flat belt open conveyors	4(c)

ITEM NO.	PURPOSE	WORKS NO.
J1	Lightweight aggregate plant	2(b) and 2(c)
J2	Ash silos	2(a)
J3	Filter bank and stack	2(d)
J4	Delivered silt storage and draining	2(f)
J5	Delivered clay storage and draining	2(f)
J6	Offices and control room	5(e)
J7	Workshops for LWA plant only	5(h)
J8	Bunded oil storage tank	5(a)
J9	Aggregate pellet storage	2(e)
J10	Clay and silt delivery and aggregate export	4(h)

ITEM NO.	PURPOSE	WORKS NO.
B1	Make up water facility	1A(ii)
B2	Bale shredders	1A(i)
C1	EFW plant 3 lines	1A(ii)
C2	EFW plant stack	1A(iv)
D1	Turbine generator hall	1A(v)
E1	Air cooled condenser	1A(vii)
F1	ASCO plant - carbon capture	1C
F2	60,000 litre bunded diesel tank	5(a)
F3	6.6Mw chiller	1C
F4	200 tonne CO2 tank	1C
F5	Tanker filling control station	5(e)
F6	Bottom ash storage and processing plant	1B
F7	Tanker filling and driver facilities	1C
F8	Fine ash transfer	1B(v)

ITEM NO.	PURPOSE	WORKS NO.
H1	Offices, Visitors centre and Control room	5(o) and 5(e)
H2	Plant workshops	5(h)
H3	Black start diesel generators	5(q)
H4	11KV Transformer and pen	5(p)
H5	EFW MCC room first floor Compressor room ground floor	5(e)
H5A	Bottom ash processing MCC room	5(e)
H6	Additives for final emissions filtering	5(h)
H7	Bunded fuel oil tank	5(a)
H8	Fire fighting water tank	5(d)
H9	Weigh bridge	5(k)
H10	Site WC - Unisex	5(f)
H11	Sewer pump house	6(b)
H12	Existing sea bank and public right of way	not applicable
H13	3 Day water storage tanks	6(b)

Dimensions of Key Buildings					
(1) Element of authorised development	(2) Work No.	(3) Maximum length (metres)	(4) Maximum width (metres)	(5) Maximum height (metres) from ground level unless stated	(6) Minimum height (metres) from ground level unless stated
Main energy recovery facility buildings (3 No. units, dimensions per unit)	1A	105	35	44	-
Energy recovery stacks (3 No.)	1A(iv)	-	-	80	-
Turbine building	1A(v)	55	40	20	-
Air cooled condenser array	1A(vii)	65	45	30	-
Ash processing building	1B	70	30	32	-
Carbon dioxide recovery building	1C	30	20	12	-
Lightweight aggregates main building	2	75	40	44	-
Lightweight aggregates storage silos	2(a), 2(e)	6	6	25	-
Lightweight aggregates stacks (2 No.)	2(d)	-	-	80	-
Electrical substation	3	95	35	-	-
Wharf	4(a)	400	-	-	7.2 (AOD)
Supporting buildings and facilities (control room, visitor centre, workshops)	5	40	20	15	-

Key

FOR LAYOUT OF SITE ITEMS SEE DRAWINGS
 PB6934-RHD-01-ZZ-DR-4011-S0-0 SHEETS 1 TO 8 OF 10



APPLICANT
**ALTERNATIVE USE
 BOSTON PROJECTS LTD**

Disclaimer

Do not scale from this drawing. Check all dimensions on site before fabrication or setting out. This document is copyright and may not be reproduced without permission of the owner.

REPRODUCED FROM ORDNANCE SURVEY MAPS
 WITH PERMISSION FROM
 THE CONTROLLER OF
 HER MAJESTY'S STATIONERY OFFICE
 CROWN COPYRIGHT RESERVED.
 LICENCE NUMBER. 100017728

REV	DATE	DESCRIPTION	BY	CHK	APP
1	11/11/2021	FOR SUBMISSION		MCP	AG PS
0	19/03/2021	FOR SUBMISSION		MCP	AG PS

TITLE
 BOSTON ALTERNATIVE ENERGY FACILITY
 DEVELOPMENT CONSENT ORDER
 Regulation 5(2)(o) - Indicative Generating Station Plans
 Item List
 BOSTON BOROUGH COUNCIL
 SHEET 10 OF 10

Application Number

EN010095

DRAWN	CHECKED	APPROVED
MCP	AG	PS
DATE	SCALE AT A1	REF.
11/11/2021	N/A	PB6934

DRAWING No.	SUITABILITY	REVISION
PB6934-RHD-01-ZZ-DR-4011	S0	1